

Remove engine cover.

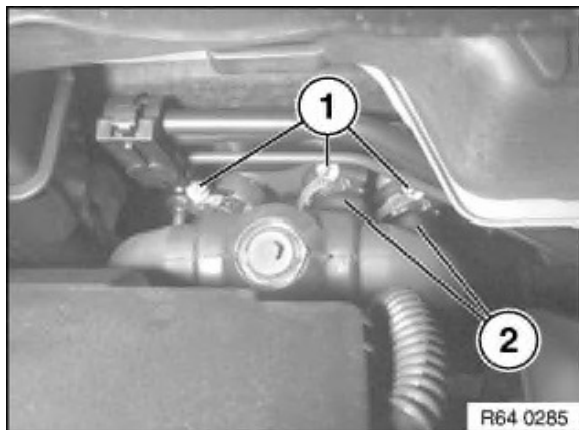

Unfasten hose clips (1) on bulkhead and pull off water hoses. Carefully blow through supply lines (2) to remove the remaining coolant from the heater core.

Installation:

Filling and bleeding the cooling system, refer to 17 00 039



Remove center console, refer to 51 16 200

Remove steering column, refer to 32 31 090

Remove left-hand side trim panel.

Remove left support pipe.

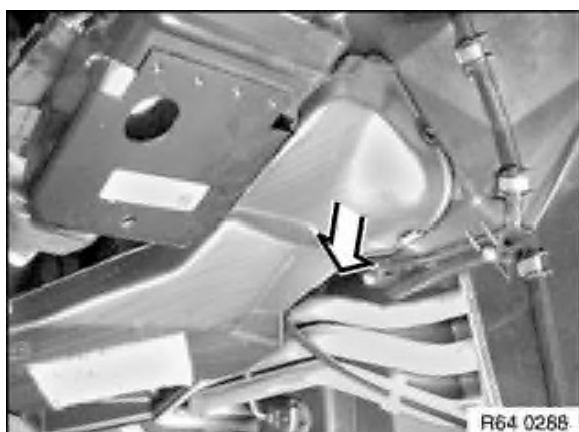

Remove left footwell air duct.

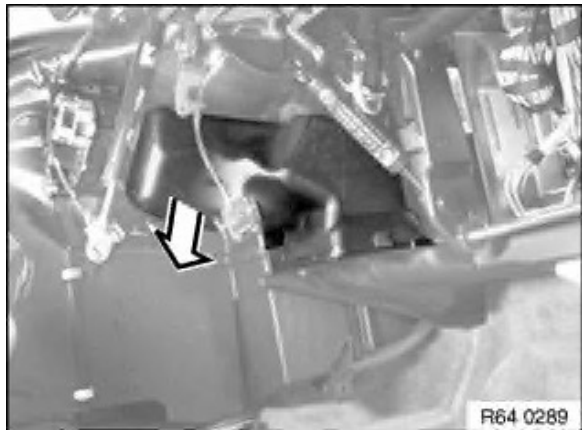

Remove right footwell air duct.

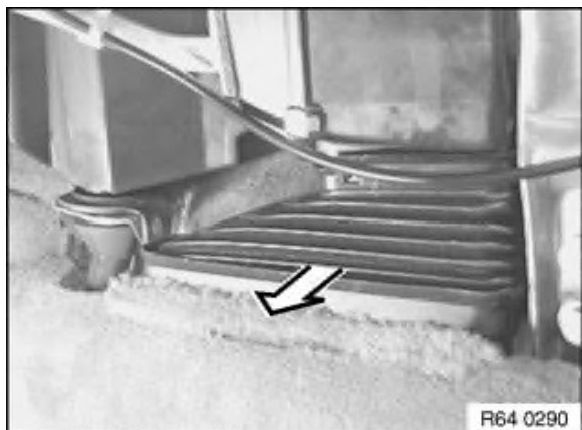

Remove left and right rear air duct.



Pry out actuator motor for right footwell flap.

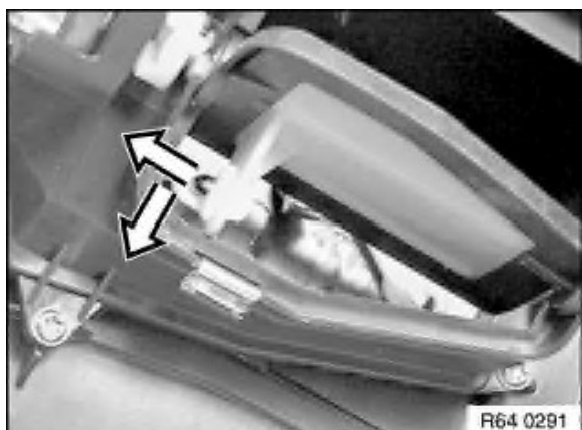

Position footwell flap approx. horizontal and unhook linkage.

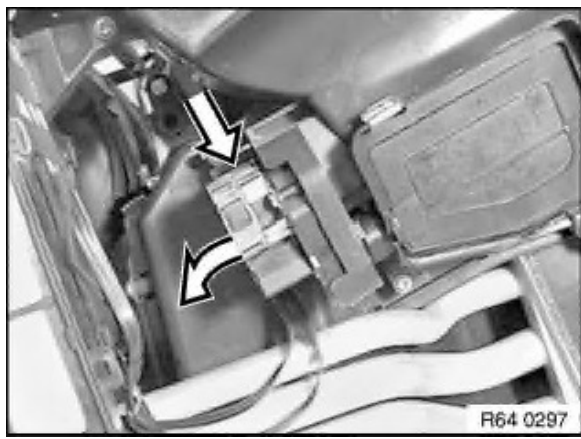

Lever out actuator motor for left footwell flap.

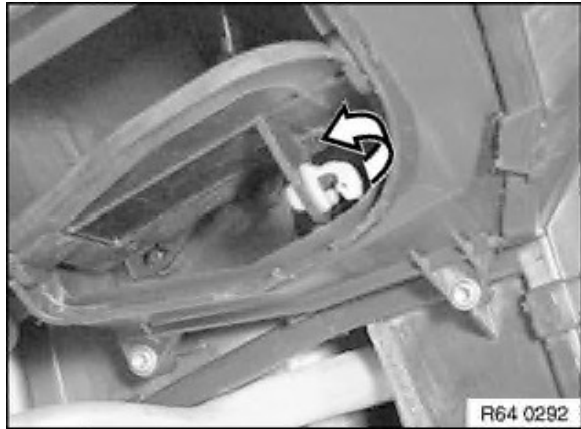

Position footwell flap approx. horizontal and unhook linkage.

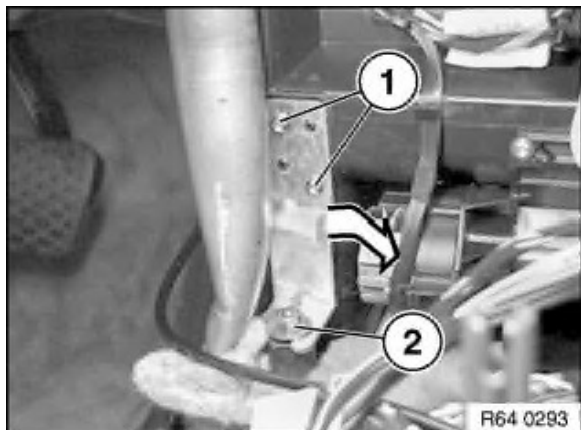

Unfasten screws (1), loosen nut (2) and pry out left and right bracket.

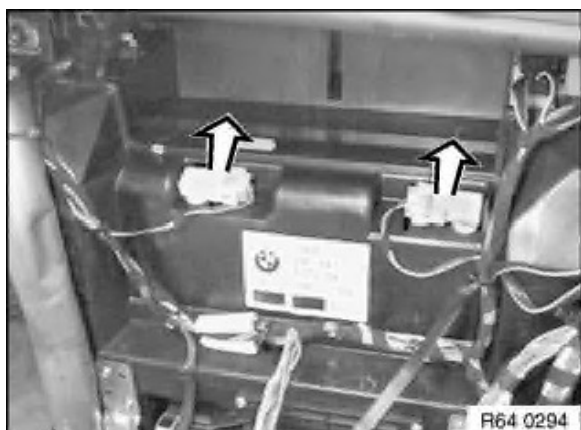

Unclip and remove temperature sensor. Cut open cable ties on the cover.

Installation note:

Secure wiring harness at existing mounting points on cover with new cable ties.

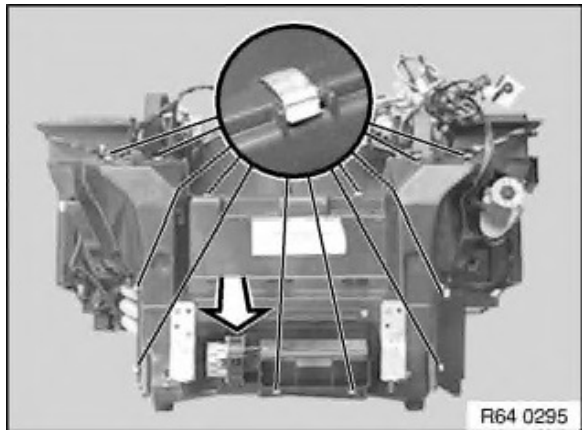

Unfasten all clips and remove heater core cover.

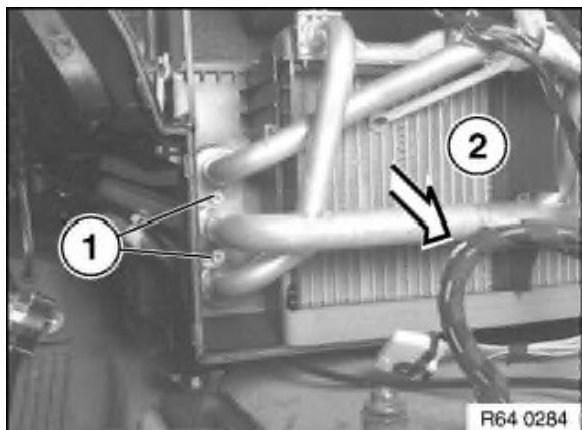

Unfasten screws (1) and pull out heater core (2).

Installation note:

Replace O-rings.

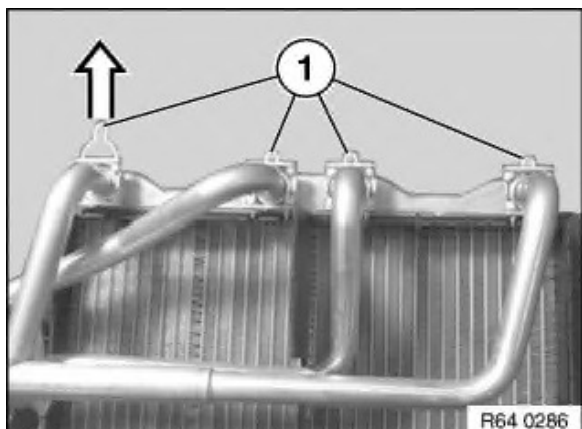

When replacing the heater core, pull out retaining clips (1) and reroute wires.

Installation note:

Replace O-rings. When installing the pipes, ensure proper seating of the O-rings.