

---

# Table of Contents

Subject	Page
<b>Brakes</b>	
Objectives of the Module . . . . .	2
Purpose of the System . . . . .	3
<b>Service Brakes</b>	
System Components . . . . .	4
Front and Rear Calipers . . . . .	4
2 Stage Brake Pad Wear Sensor. . . . .	5
Brake Control. . . . .	5
Brake Discs . . . . .	6
Wheel Speed Sensors. . . . .	6
Workshop Hints . . . . .	8
<b>Parking Brake (EMF)</b>	
Purpose of the System. . . . .	9
Functions . . . . .	10
System Components . . . . .	11
Electro-mechanical Actuating Unit. . . . .	12
Emergency Release . . . . .	14
Principle of Operation . . . . .	16
Safety Concept . . . . .	22
EMF Self Diagnostics . . . . .	25
Workshop Hints . . . . .	26
Check Control and Control Display Fault Descriptions . . . . .	28

---

# BRAKES

**Model: E65 - 745i**

**Production Date: 11/2001**

## Objectives of The Module

After Completing this module, you will be able to:

- Identify the front brake calipers.
- Explain the 2-Stage Brake Pad Wear Sensor.
- Demonstrate parking brake operation including "Auto Hold" activation.
- Understand the brake lining "seating" (special function) after the parking brake linings have been replaced.
- Explain how the EMF applies the parking brake.
- Demonstrate the EMF emergency release procedure.
- List and perform the procedure to resume operation after an emergency release.
- Describe Dynamic Braking.

---

## Brakes

### Purpose of The System

The brake power is designed for the weight and the driving performance of the E65. The E65 features a vacuum boosted dual-circuit hydraulic brake system with "front/back" distribution. The brake system offers the high safety reserve characteristic of BMW. The service life of the brake pads and discs as well as the noise characteristics have been improved. The front brake calipers are aluminum to reduce the unsprung weight. The 2-phase brake pad sensors on the left front and right rear convey signals to the DSC control module making it possible to calculate the total brake pad service life (Condition Based Service).

The electro-mechanical parking brake is automated and functions with the DSC hydraulic system. The stopping function is controlled by the DSC hydraulics when the engine is running and by the electro-mechanical drum brakes (integral in the rear rotors) when the engine is switched off. The parking brake is actuated by a push button. The driver has the opportunity to activate the "Automatic Hold" function which automatically applies and releases the brake. This prevents "creeping" in stop and go traffic and "roll back" before pulling away on an incline (Hill Hold).

The parking brake can only be released when the ignition is switched "ON" (childproof safety benefit). When the engine is switched off with the Automatic Hold function active, the electro-mechanical parking brake will be applied. In addition, the parking brake control module provides automatic wear compensation (adjustments are not necessary) and is diagnosable. The control module is located under the luggage compartment and has a manual emergency function in the event of a system failure.



---

## Service Brakes

### System Components

**Front Brake Calipers:** The single piston floating front brake caliper housings are made of aluminum. The reinforcement frame surrounding the brake caliper prevents spreading from contact pressure on the brake disc.

The brake caliper mounting bracket is made of zinc-nickel coated cast iron. The coating satisfies both the increased corrosion protection requirements as well as the European directive for chromium free components (enforced from 7/2003 on).

A cover is installed to improve the appearance of the brake caliper and to support the retaining spring. The brake pad thickness can be measured through the inspection hole in the center.



1. Opening for measuring brake pad thickness
2. Cover
3. Retaining spring
4. Spheroidal cast iron mounting bracket
5. Aluminum housing

42-06-01

#### Front Brake Caliper

The single piston floating caliper code for the 745i is FNR-Al 60/30/348:

- FN - Supplier (Continental-Teves)
- R - Frame
- Al - Aluminum
- 60 - Piston Diameter (mm)
- 30 - Brake disc thickness (mm)
- 348 - Brake disc diameter (mm)

**Rear Brake Calipers:** The single piston floating rear brake calipers are made of zinc-nickel coated spheroidal cast iron. As on the front calipers, the coating satisfies both the increased corrosion protection requirements as well as the European directive for chromium free components (enforced from 7/2003 on). The single piston floating caliper code for the 745i is FN 46/24/345:

- FN - Supplier (Continental-Teves)
- 46 - Piston Diameter (mm)
- 24 - Brake disc thickness (mm)
- 345 - Brake disc diameter (mm)

**2-Stage Brake Pad Wear Sensor:** The 2-stage brake pad wear sensors located at the left front and right rear are monitored by the DSC control module for continuous calculation of the brake pad wear. In the first stage of wear through, the brake pad wear indicator operates in the same way as on previous models. A resistor (470 ohm) is integrated in the second wear through stage.

1. Stage 1 circuit (6 mm)
2. Stage 2 circuit with resistor (4 mm)
3. Brake disc
4. Brake pad wear sensor

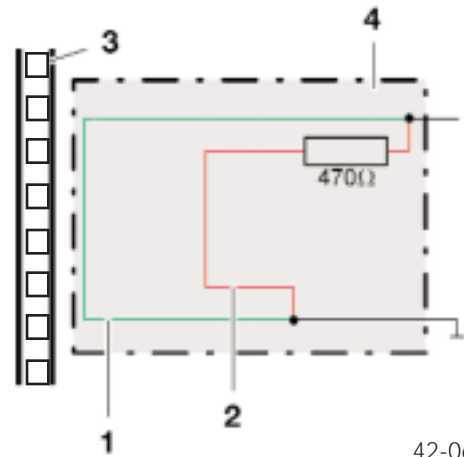

42-06-02

**Brake Pad Wear Sensor**

The control module monitors the wear status based on voltage change. The first stage of the wear indicator is activated with 6 mm (lining thickness) remaining and the second stage with 4 mm remaining.

With these two different voltages, the probable total service life of the brake pads is calculated by the DSC control module. The criteria considered by the DSC module to perform the remaining mileage calculation are: wheel speed, mileage, brake pressure, brake disc temperature and brake operating time. The remaining mileage of the brake pads can be read in the Control Display (Condition Based Service) as required.

After switching off the ignition, the calculated remaining mileage for the front and rear brake pads is stored and is the start value when the vehicle is in operation again. The service life is shown separately in the Control Display for the front axle and rear axle. The brake pad thickness can be measured through the "mounted" wheel using the Special Tool (refer to the Repair Instructions of TIS).

**Brake Control:** The brake system is controlled with a dual (8"/9") aluminum vacuum booster and a tandem master cylinder with a brake fluid reservoir. The brake booster is compact because the power assistance is enhanced by the engine driven vacuum pump.

**Note:** DOT4 brake fluid is recommended for all E65 models with a 2 year replacement interval.

**Brake Discs:** The E65 is equipped with vented brake discs on the front and rear axle made of high carbon cast iron. The brake disc surfaces are coated with Geomet to satisfy the increased corrosion protection requirements as well as the European directive for chromium free components (enforced from 7/2003 on).

Geomet is a zinc-aluminum surface coating (microfine scaled surface pattern) that is sprayed on and baked at 300 °C. It is environmentally compatible and features outstanding corrosion protection properties. On the friction surface of the discs, the protective coating is worn down without any changes in the coefficient of friction. All other surfaces retain the corrosion resistant coating over the entire service life.

*Note: An initial scraping sound is normal and will disappear after the first few braking applications.*

**Brake Guard:** The ventilated brake guards (plates) on the front and rear axle are made of aluminum and are shaped for effective water drainage. A rubber element is installed between the brake guard and wheel bearing to prevent noise transmission.

1. Rubber element
2. Wheel hub
3. Brake guard, rear axle



**Brake Guard**

**Wheel Speed Sensors:** Hall effect direction sensing wheel speed sensors are used on the E65. A special feature of this sensor is that forward and reverse rotation is detected. The sensor contains three Hall effect elements located next to each other in one housing. The signals of the first and third Hall element form a raw differential signal for determining the signal frequency (speed) and the air gap clearance to the impulse wheel.

1. Hall-effect elements
2. Differential signal (magnetic)
3. Center Hall element signal (magnetic - rotational direction)
4. Output signal to DSC control module

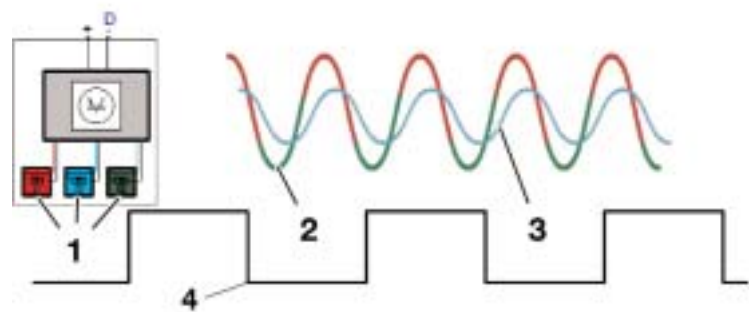

**Wheel Speed Sensors**

Clockwise or counterclockwise rotation is detected by the phase offset of the signal from the middle (second) element as compared to the differential signal. The phase will shift (left or right) depending on the impulse wheel's approach to the Hall element from the left or the right.

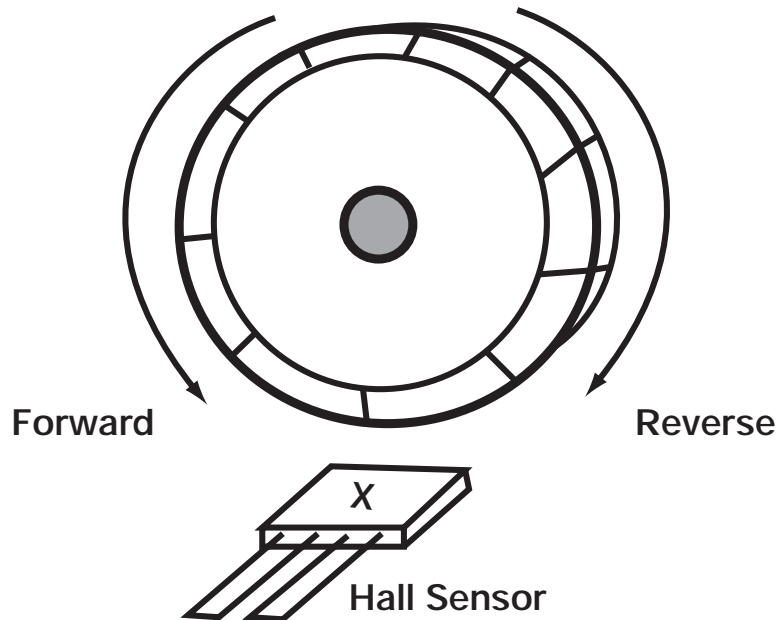

42-06-05

The direction of rotation phase (3) will shift to the left or to the right (as shown) of the differential signal (2). These signals are processed in the sensor and are represented in the output pulse width digital signal (4) that is monitored by the DSC control module.

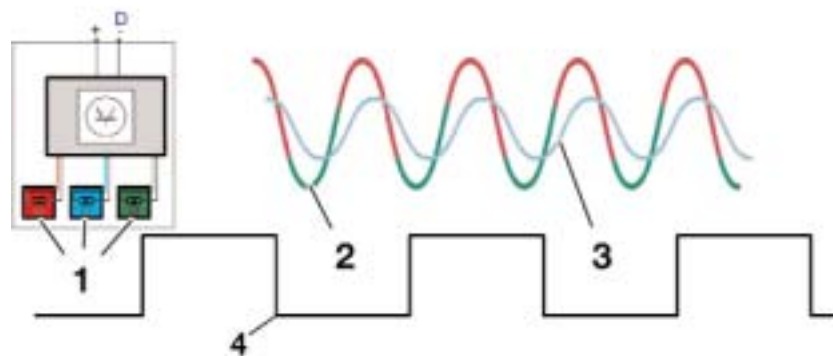

42-06-06

This sensor contains two external wires and the digital signal is transmitted over the **combined ground and data line** (D) to the DSC control module. The second wire is the power supply for the wheel speed sensor.

---

The flow of current is the influencing factor, not the voltage level. This provides a reoccurring data message that uses two different amp ratings. The 14 mA level contains the information of speed, direction of rotation and air gap. The 7 mA level is the evaluation current for the fault code memory. When the vehicle is stationary, a pulse is sent every 740 ms to check the sensor circuit integrity.

## **Workshop Hints**

The tightening torque requirements of the fastening bolts for the brake hoses have been changed (refer to TIS tightening torques).

*After replacing the brake pads, the residual mileage stored in the DSC control module must be reset separately for each axle to a new start value using the DISplus.*

*When the DSC control module is replaced, the specified remaining mileage for the front and rear brake pads must be transferred into the new DSC control module using the DISplus.*

*Notes:*

---

---

---

---

---

---

---

---

---

---

---

---

---

---

---

---

---

---

---

---

---

---



## Parking Brake (EMF)

### Purpose of The System

The Electro-mechanical Parking Brake (EMF) is used for the first time in series production. The EMF is used to secure a stationary vehicle, preventing it from rolling away by firmly locking the parking brake. The EMF is an automatic comfort oriented system that replaces the previous handbrake or foot operated parking brake. The driver can apply and release the parking brake by pressing a push button.

The system is designed for the characteristic requirements of the E65:

- Consideration for safety
- Optimum functionality
- Maximum system usage
- Best comfort and convenience

The Parking Brake push button is located in the instrument panel to the left of the headlight switch. The push button is an integral component of the Light Module.



42-06-06

The EMF mechanically locks the parking brake when the vehicle is stationary and provides an independent brake system as required by law (in addition to the service brakes).

The EMF system offers additional comfort and safety functions.

1. EMF actuator
2. Bowden cable
3. Drum brakes (integral in the rear brake discs)

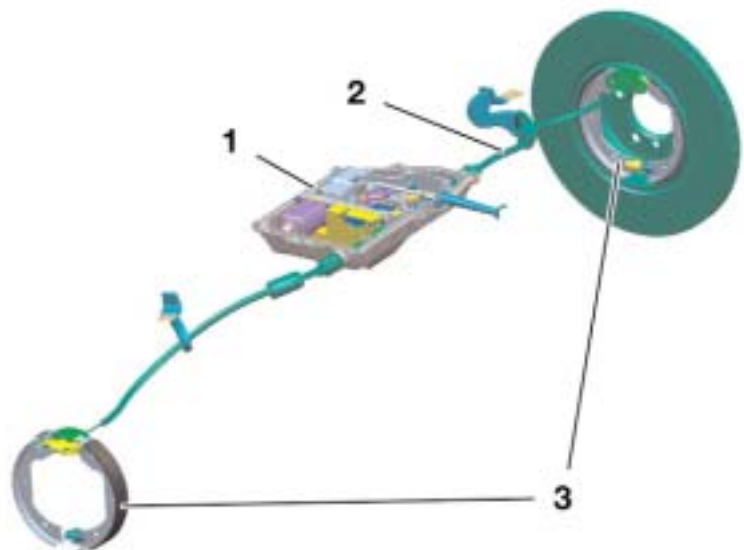

EMF System

42-06-08

---

**Basic Functions:** There are two different parking brake functions depending on the operating status of the vehicle.

***Locking (Brake Applied):***

- With the engine running or the vehicle rolling, the parking brake function acts on the front and rear axle by the DSC hydraulically applying the service brakes.
- When the engine is not running and the vehicle is stationary, the electro-mechanical parking brake is applied.

***Dynamic Braking:***

- Braking required to decelerate a moving vehicle is identified by the DSC system when the parking brake push button is pressed while driving. The braking procedure is regulated by the DSC hydraulically applying the service brakes and takes place for as long as the push button is pressed.

**Automatic Hold:** This comfort function is selected using the controller or with the free programmable button on the multifunction steering wheel. After braking to a standstill, the vehicle is held by the DSC hydraulically applying the service brakes. The brakes are released by pressing the accelerator pedal. The hold and release function prevents “creeping” in stop and go traffic and “roll back” before pulling away on an incline (Hill Hold).

**Brake Pedal “Feel”:** The response of the brake pedal may change slightly (accompanied by an activation sound) because the parking brake function is activated using the brake system’s hydraulic circuits - this is normal.

**Emergency Release:** A mechanical emergency release is provided to release the parking brake in the event of an actuating unit failure or a dead battery. It is possible to release the mechanical actuating parking brake unit using the emergency release tool and an open end wrench found in the vehicle tool kit.

**Note:** In addition, refer to the automatic transmission section for the emergency mechanical parking lock release procedure.

**Special Function:** During vehicle operation, brake lining “seating” is conducted at defined intervals to ensure and maintain the effectiveness of the parking brake. The brake lining seating is performed to remove corrosion from the parking brake shoes and brake drums. The procedure automatically takes place approximately every 1000 km or once a month and is transparent to the driver.

## System Components

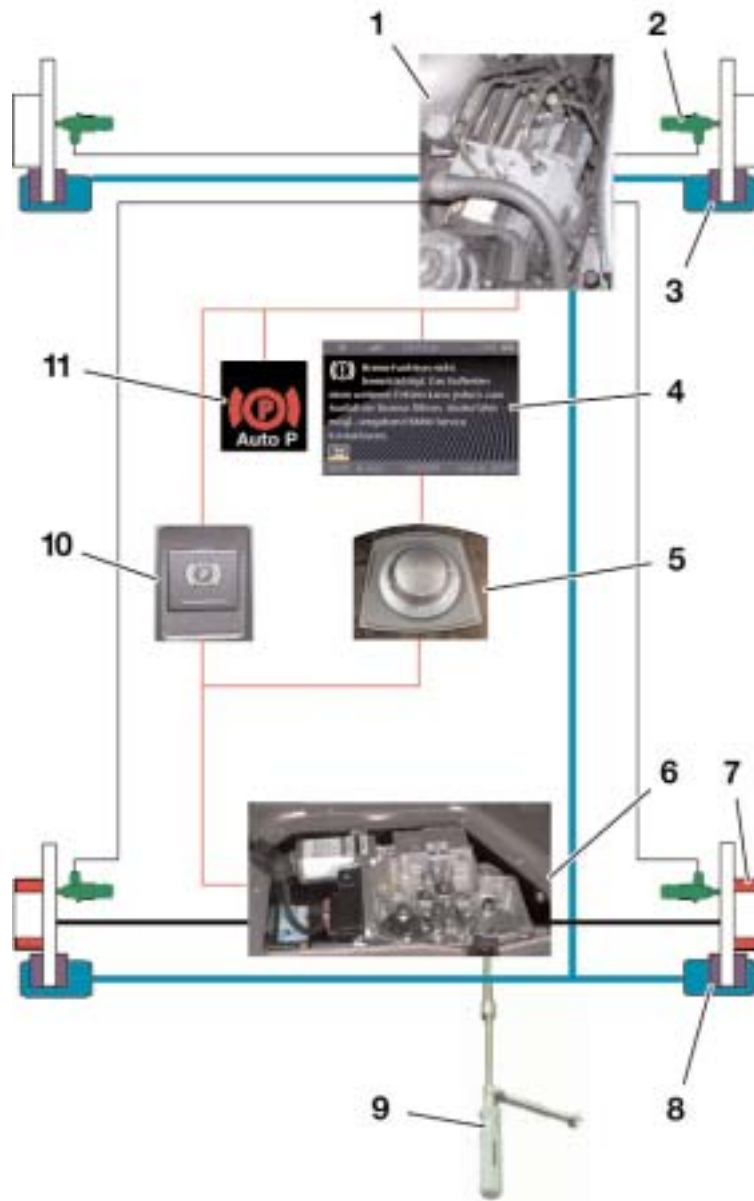

EMF Parking Brake

42-06-09

- |                              |                                       |
|------------------------------|---------------------------------------|
| 1. DSC module                | 7. Parking brake                      |
| 2. Wheel speed sensors       | 8. Service brake, rear axle           |
| 3. Service brake, front axle | 9. Mechanical emergency release tools |
| 4. Control display           | 10. Parking brake push button         |
| 5. Controller                | 11. Display in instrument cluster     |
| 6. EMF actuating unit        |                                       |

**Electro-mechanical Actuating Unit (EMF):** The EMF receives the parking brake request and activates an electric actuator (motor) to tension the parking brake cables. The EMF actuating unit is located under the luggage compartment floor in front of the spare wheel recess.

1. Actuator (motor with 2 Hall sensors)
2. Gear mechanism
3. Balance arm
4. End stop
5. Guide tube for emergency operation (release)
6. Cable module
7. Control module
8. Bowden cable (one of two)

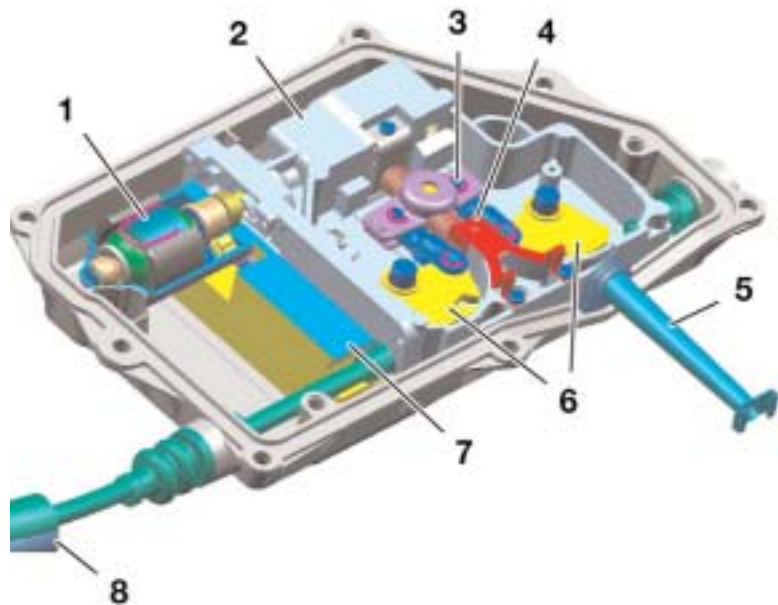

**End Stop:** The end stop is the “zero point” for the initial position which is required for the parking brake cable installation (release - no tension).

The balance arm rests against the end stop the first time the brake is released when the ignition is on (KL15).

Hall sensors are mounted on the motor to detect the speed and position. The control module detects the end stop by the increase in actuator motor current and the decrease in the motor speed (Hall sensors).

1. Electric motor
2. Hall sensors
3. Spindle (worm)
4. Control module

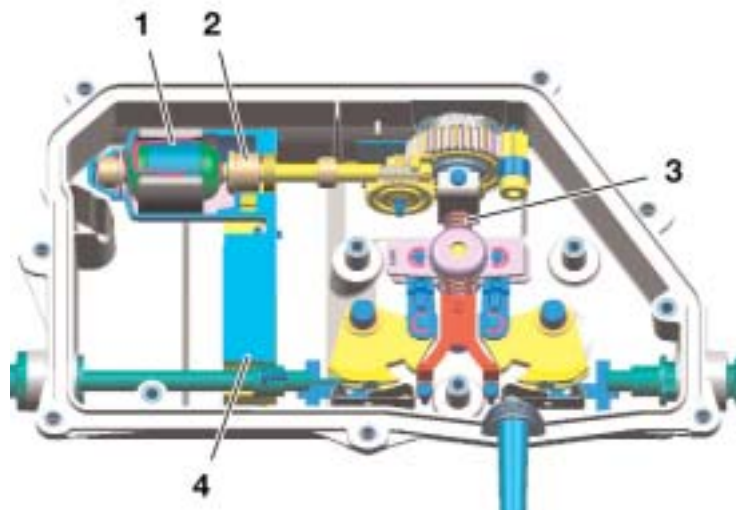

42-06-10

Electro-mechanical Actuating Unit

42-06-04

EMF Actuation

When activated, the spindle is turned by the motor using a gear drive mechanism to apply the parking brakes. The balance arm is pulled by the spindle (worm) and will compensate for the slight difference in side to side cable length. The balance arm is linked by connecting levers to pull the cable pulleys inwards towards the direction of the spindle rotation. The cables are attached to the cable pulleys which are pulled "in" to apply the parking brakes. Once the hold position is reached, the spindle worm gear ensures cable tension and will not release with out spindle rotation.

1. Cable pulley
2. Actuator motor
3. Balance arm
4. Gear drive mechanism
5. Spindle
6. Control module

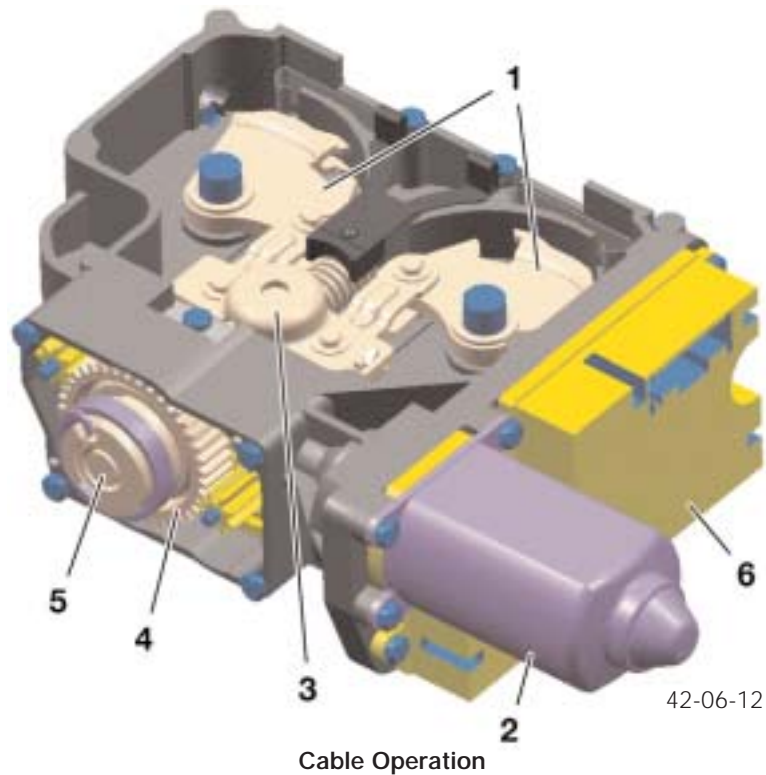

**Gear Drive Mechanism with Coil Spring:** This is designed as a three stage (reduction) gear mechanism consisting of a worm, spur gear and spindle. The holding force for the parking brake is assisted by a coil spring mounted on the end of the spindle.

1. Spindle
2. Coil spring cover
3. Coil spring
4. Emergency release drive gear

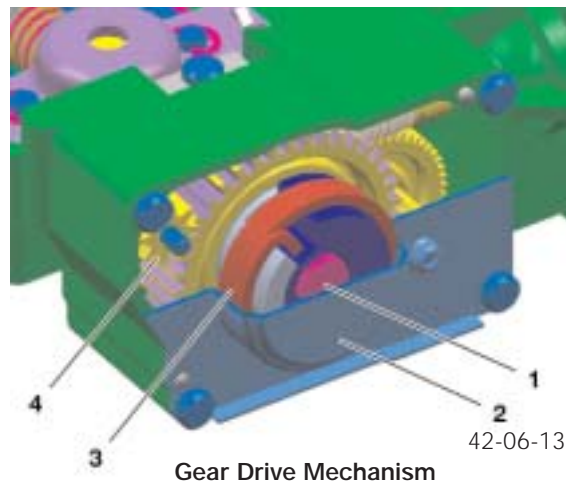

When the brake is released, the spindle is turned by the motor and gear drive mechanism in the opposite direction. The balance arm, connecting levers and cable pulleys are pushed outwards by the spindle (worm). The cables are also pushed “out” to release the parking brakes. To assist in the release, return springs are installed in the parking brake assemblies inside the brake discs.

**Note:** With the manual emergency release, the spindle can be turned through the gear drive mechanism with the tools found in the vehicle tool kit to release the parking brake.

## Workshop Hints

**Emergency Release:** The parking brake is manually released directly through the gear drive mechanism.

The tools in the vehicle tool kit to release the parking brake are:

1. Screwdriver handle
2. Emergency-release tool (spring loaded)
3. 10 mm open-end wrench



42-06-09

**Caution:** Make sure the transmission is in the Park position before releasing the parking brake!

Emergency Release

To release the brake, the extension rod is inserted through a guide tube located in the luggage compartment floor in front of the spare wheel recess (1). Maintain pressure on the tool.

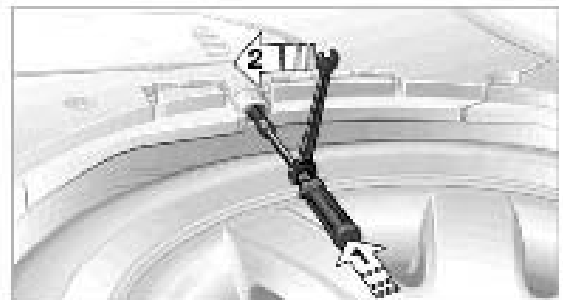

42-06-10

**Note:** After a power failure/interruption, it is possible that the vehicle can not be moved after releasing the parking brake using the emergency release. The parking lock of the automatic transmission can still be engaged. Refer to the automatic transmission section for the emergency mechanical parking lock release procedure. **The parking brake may only be used again if it is released manually after a power interruption. If this is not performed, the parking brake may fail to operate correctly!**

**Resuming Operation after Emergency Release:** When the voltage supply has been restored after the emergency release, the parking brake *push button must be pressed 3 times at intervals of approx. 5 seconds to initialize the system.* This procedure is also described in the Owner's Handbook and Towing Instructions for BMW 7 Series.

- **1st press** - The control module attempts to release the brake. Since the brake has been released mechanically by the emergency release, the motor cannot run back and blocks. The control module recognizes a disengaged setting.
- **2nd press** - The motor will move forward applying the parking brake. The control module detects an engaged setting. The "P" indicator light illuminates in red.
- **3rd press** - The motor will run backward releasing the parking brake and the "P" indicator light goes out. The parking brake is ready for operation.

**Control Module:** The parking brake control module (integral in the EMF) is linked to other control modules for communication by the PT-CAN and K-CAN Busses. Diagnostic communication is provided through the ZGM over the PT-CAN Bus.

- LM Light module
- DSC Dynamic stability control
- TEMP Parking brake push button
- CAS Car access system
- ZGM Central gateway module
- DFA VL speed signal (separate hard wire backup), left front wheel

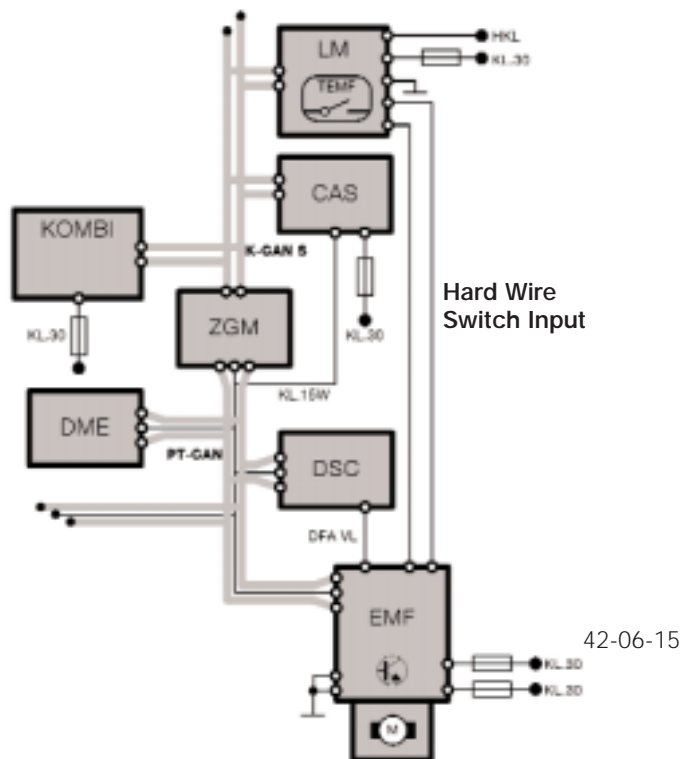

When the parking brake push button is pressed with the engine running, a fixed brake pressure is built up by the DSC hydraulic unit and applied to the service brakes.

The force applied at the spindle is calculated in the parking brake control module. The control module first determines the current flow of the actuating motor accounting for the temperature of the motor coil (affecting resistance). Hall sensors are mounted on the motor to detect the speed and position. The actuating force is calculated by evaluating the speed reduction of the motor (speed is a function of torque).

## Principle of Operation

### Parking Brake Control

Two separate controls are provided to operate the parking brake functions.

1. **The Push Button**, located in the instrument panel to the left of the steering wheel is used for the basic function. This will apply and release the parking brake when the vehicle is stationary and provide "Dynamic Braking" when the vehicle is driven depending on the vehicle speed.

When the vehicle is stationary, it functions as an ON/OFF (momentary) push button. Only in the Dynamic Braking mode, the brake is applied for as long as the button is pressed.



42-06-08

2. **The action field in the menu of the control display** provides a second control. The menu screen is activated and controlled by the driver to activate or deactivate the "Automatic Hold" parking brake function.

This function can also be activated and deactivated with the free programmable button on the multifunction steering wheel (if set in the Control Display).



42-06-07

### Indicator Lights

The driver is informed of the parking brake system status by an indicator light in the instrument cluster. When a fault is present, an additional message in the Control Display will provide more information. The parking brake control module communicates via the PT-CAN and K-CAN Busses. The light is activated as part of the pre-drive check when the ignition is switched on.

Parking brake indicator lamp

Function lamp



42-06-17



---

## Indication

In the basic function, application of the parking brake is indicated by a red LED in the brake symbol and by the letter P on the inside. The letters "PARK" are illuminated in the indicator light for as long as the parking brake is applied.

The P symbol indicates that the requested status of "release" or "apply" is reached. When the parking brake is operated while driving (Dynamic Braking), an acoustic warning signal is additionally activated (multiple gong).

## Automatic Hold Indication

Standby of the automatic hold function is indicated by the green lettering "AUTO-P" integrated in the light. The parking brake signal is additionally indicated when the automatic hold function is active and the vehicle is stopped. The parking brake symbol lights up in green because the hold function is activated by the DSC with all 4 wheel (service) brakes.

After the brake has been released when starting off (automatically), the green parking brake symbol goes out and only the green standby indication "AUTO-P" remains active. The transition from hydraulic to mechanical mode takes place automatically when the engine is switched off. The light changes from green to red indicating the parking brake is applied and the DSC (service brakes) are released.

## Additional Indication

The driver is alerted of parking brake malfunctions by a yellow indicator light in the instrument cluster. In addition, the same symbol is illuminated in the variable indicator warning field and briefly explained by a text note.

In addition to the parking brake status, the variable indicator light is also made available to other control modules. It is only used by the parking brake control module for specific faults.

When the variable indicator light appears, the fault is explained in the Check Control display accompanied by additional information in the Control Display (Condition Based Service).

1. Parking brake indicator light
2. Check Control display
3. Variable indicator warning field



*Indication Examples:*

Instrument Cluster

System function	Indicator lamps
Parking brake released	 KT-8140
Parking brake applied	 KT-8141
Dynamic braking + Acoustic signal (gong)	 KT-4990
Automatic hold standby	 KT-8848
Automatic hold active	 KT-8849
System error	 KT-8150

---

## Basic Parking Brake Function with the EMF

**Situation: "Ignition ON" and the engine is not running.** When the vehicle is stationary, the parking brake is released or applied by pressing the push button. The light in the instrument cluster is either not lit or is red. The lettering "PARK" is illuminated while the brake is released or applied. Pressing the button while the vehicle is rolling triggers the dynamic braking function.

**Changing from the EMF to DSC:** When the EMF is applied and the engine is started, the system changes over to the service brakes using the DSC. The EMF is not released *until* the service brakes are applied. The light is permanently red and the transfer is not indicated to the driver (transparent).

**Changing from DSC to EMF:** When automatic hold is activated *or* the ignition is switched "OFF" (even if automatic hold was not activated), the service brakes are released *after* the changeover to the EMF takes place. If automatic hold was activated, the indicator light changes from green to red. If the service brakes are applied, they will be released *after* the changeover to EMF. The indicator light will remain red during this changeover.

## Parking Brake Function with DSC (Service Brakes)

**Situation: "Engine Running".** When the push button is pressed, the service brakes are released or applied by the DSC and the indicator light is either off or red. When the vehicle is moving and the push button is pressed, Dynamic Braking is applied.

The parking brake push button acts as a switch at speeds below 3 km/h, pressing the push button once will trigger an immediate function change. The brakes are released before starting off by pressing the push button. When attempting to start off without releasing the parking brake, the DSC will further increase the service brake pressure and a warning (gong) will alert the driver. *When the parking brake is set and the driver exits the vehicle (CAN signal - driver's seat occupancy) with the engine running, the EMF parking brake will be applied in addition to the DSC service brakes.*

## Ignition Key Removed (Rest Status)

When the parking brake is applied, the P-light remains on for a certain period indicating "brake hold" to the driver. *The parking brake can be released at any time by pressing the push button until the ignition key is removed (car wash function).* The rest status is assumed when the ignition key is removed. The parking brake can not be released when the ignition key removed (child safety). The ignition key must be inserted and the ignition switched on to release the parking brake.

---

## Automatic Hold Function

The Automatic Hold function is activated by selecting "Auto P" in the Control Display (or MFL free programmable button) **only when the engine is running and the hood is closed** (or the hood contact switch is in the service position). It then remains operational until the next time the engine is switched off. When selected, the vehicle is automatically held by the service brakes each time it comes to a stop. This also applies when the Automatic Hold function is requested and the vehicle is stationary.

When the vehicle is stationary, the brake pressure that the driver applies from the brake pedal is "locked in". When the vehicle comes to a stop without operating the brake pedal (roll to a stop), hydraulic pressure is built up by the DSC pump. Increased pressure will be automatically supplied if the vehicle begins to roll (detected by the wheel speed sensors).

When the automatic transmission is engaged in a drive gear, the brakes will be automatically released by pressing on the accelerator pedal. The next time the vehicle stops it will be automatically held by the service brakes. The standby status of the automatic mode is indicated by the green lettering "Auto-P". When the vehicle is stationary, the parking brake symbol is additionally illuminated in green.

The Automatic Hold function is deactivated by selecting "OFF" in the Control Display (or MFL free programmable button). This will not change the current parking brake status. This means when the vehicle is stationary, it remains held hydraulically after selecting "Auto-P OFF". The parking brake indicator light will change from green to red and the "Auto-P" indicator will go out.

The Automatic Hold function is always aborted when the push button is pressed and must be reactivated by selecting "ON" in the Control Display (or MFL button). When the engine is switched "OFF" in the Automatic Hold function, the EMF will apply the parking brake.

The parking brake can be released at any time by pressing the push button until the ignition key is removed (car wash function). The parking brake will apply after the ignition key has been removed.

## Automatic Hold Safety Control

Release of the Automatic Hold function by pressing the accelerator pedal is based on two safety functions.

**Situation: Hood open.** Automatic release of the service brakes when the accelerator pedal is pressed is inhibited when the hood is open (CAN signal - hood contact switch) while the engine is running.

---

In this situation, the parking brake can only be released by pressing the push button (Automatic Hold deactivation). When the hood is closed, the Automatic Hold must be selected again by the driver. This situation also applies when the luggage compartment (trunk) lid is open and Reverse is engaged.

**Situation: The driver exits the vehicle.** When the driver exits the vehicle (CAN signal - driver's seat occupancy) with the engine running, the automatic release of the service brakes by pressing the accelerator pedal is inhibited. The EMF parking brake will also be applied and the transmission will automatically shift to the P-position.

When the driver re-enters the vehicle (CAN signal - driver's seat occupancy), the brake pedal must be pressed and a transmission drive gear must be engaged to drive off. The brake light switch signal requests the EMF to release the parking brake. The Automatic Hold function must be selected again by the driver.

## Dynamic Braking

Two separate controls are required by law for brake operation, the brake pedal and hand-brake lever were previously used. In the E65, the footbrake and the push button in the dashboard fulfills the requirements.

When the vehicle is moving and the engine is "OFF", the EMF parking brake is applied when pressure is maintained on the push button at speeds below 3 km/h. During this situation, the parking brake is applied for 0.8 seconds. For the next 2 seconds there is an increase in the braking power and the rate of deceleration is maintained as long as the push button is pressed.

The Dynamic Braking function is active while the vehicle is rolling at speeds above 3 km/h (when the ignition is in position KLR or KL15) when pressure is maintained on the push button. This maintains vehicle stability by preventing overbraking of the rear axle using DSC hydraulic pressure build-up application to the service brakes. The required brake pressure is made available as fast as possible by the DSC.

Since braking takes place hydraulically on all four wheels, higher deceleration rates are possible with minimum operating force as compared to the EMF parking brakes. This controlled braking contributes to increased vehicle safety. ***For safety reasons, traffic is warned when Dynamic Braking is active by the brake lights.***

To avoid incorrect operation, the "Release Parking Brake" display and gong draw the driver's attention to Dynamic Brake operation. ***This function should only be used in exceptional circumstances.***

When Dynamic Braking is activated until the vehicle comes to a stop, the vehicle will remain held by the service brakes and the red P-indicator light remains on. If the brake pedal is pressed during this operation, the DSC interprets this as a higher priority and will override the parking brake function.

**Exiting the dynamic emergency braking function:** After emergency braking the vehicle to a stop, the vehicle will remain held by the service brakes even after releasing the parking brake push button. The service brakes will not be released until the push button is pressed again.

## Safety Concept

### Fault Messages

The EMF and DSC control modules monitor the system for faults and alert the driver. A fault has different priorities depending on driving situations: vehicle stationary/moving and starting off/deceleration. To avoid damage, faults in the EMF actuating mechanism like cable breakage and stretch (actuating range exceeded) are detected by the Hall sensors in the motor.

If the EMF control module is defective, fault messages will not be available. The instrument cluster recognizes the absence of the normally active parking brake message (alive - enable) over the PT-CAN Bus and will display a fault message. The safety concept is based on a staged shut down strategy. In addition to the yellow warning light, information is available in the Control Display.

Fault	Availability	Availability	Availability	Back-up system
	Parking brake (mechanically) $v=0$	Dynamic braking (hydraulic) $v>0$	Automatic hold	
Can signal error	OK	OK	Not available	Service brake + auxiliary brake
DSC Hydraulics fault	OK	Not available	Not available	Service brake + auxiliary brake
Actuating mechanism fault	Not available	Ok	Not available	Park position automatic gearbox
Fault in parking brake control unit	Not available	Not available	Not available	Park position automatic gearbox and, if applicable service brake + auxiliary brake

---

## General Parking Brake Fault Concept

*Fault division between DSC and EMF control module:* DSC faults that only affect the parking brake will result in a shut down of the hydraulic function (Dynamic Braking not possible). These are typically faults that result in a shut down of the ABS functions and Manual Emergency Mode will be assumed by the EMF. If the fault is only a CAN Bus fault, Dynamic Braking will be possible.

### Shut Down Stage of "Manual Emergency Mode"

This will only apply when the EMF actuating unit is not in operation and is implemented for one of the following DSC faults:

- DSC control module defect
- Electrical defect (example: wiring harness)
- Sensor fault (brake pressure sensor, wheel speed sensors)
- EMF actuator fault, DSC hydraulic unit
- CAN communication fault

### Shut Down Stage "Only Dynamic Braking Available"

This stage will provide Dynamic Braking by the DSC hydraulic service brakes in the event of an EMF actuating failure.

- Fault in the actuating motor Hall sensors
- Actuating motor fault
- Fault in control electronics
- Fault in actuating mechanism (mechanical)
- Electrical faults

### Shut Down Stage "Total Shut Down"

- Parking brake control module failure
- Push button fault
- Electrical faults including voltage supply

All fault codes are stored in the EMF control module and is also informed of the DSC control module fault status.

---

## Fault Regeneration

If a fault is detected, the system remains in the current stage until the ignition is switched "OFF". A shut down situation will not be deactivated until the faulty component is operating correctly. If the fault is not present during the next restart, the shut down stage is cancelled to resume normal operation. Component tests are carried out continually, even during the shut down situation.

The fault information remains stored in the fault code memory. If correct function of the component cannot be determined after a fault has occurred, the parking brake will remain in the safe, shut down state until the next workshop visit with the exception of: CAN timeout error, overvoltage and temperature protection. After properly repaired, the fault can be deleted with the DISplus.

## Regeneration of CAN Faults

CAN timeout faults can be regenerated. The shut down stage is cancelled if the signal is received correctly for a certain period of time.

## Monitoring and Fault Detection

**Electrical faults monitoring:** The wiring to the EMF control module including the actuator motor are monitored for breaks or shorts to B+ and ground.

**Hydraulic interface monitoring:** The DCS checks the plausibility of the deceleration request by the parking brake during Dynamic Braking and the hydraulic Hold Function. If the request and feedback do not agree within a defined time (5 seconds), the corresponding shut down stage is assumed and a fault code will be stored.

**Input signals monitoring:** In the event of a faulty input signal, the entire system is shut down with a Check Control error message and a stored fault code.

**Parking brake push button monitoring:** The push button signals are continually monitored (hardwired to the EMF control module). In the event of a push button plausibility fault, the entire parking brake system is shut down and the "Parking Brake Push Button Defective" fault code is stored. The DSC control module also checks the plausibility of the parking brake push button signals that are transmitted via the CAN Bus (from the EMF control module). If faulty, the "Parking Brake Push Button Signals via CAN Implausible" fault code is stored and partial shut down is carried out (Dynamic Braking is not possible).



---

**Speed signals monitoring:** Total shut down of the parking brake system will occur with the loss of all 3 speed inputs.

- The direct digital wheel speed signal (separate hard wire backup, front left) is continually checked for the plausibility of the signal edge change.
- The plausibility of the reference speed signal from the DSC over the PT-CAN Bus and the direct digital wheel speed signal is continually and mutually checked.
- The reference speed signal from the DSC is compared with the automatic transmission output speed.

Fault codes:

- Direct wheel speed signal implausible or faulted
- DSC speeds implausible or no message
- EGS automatic transmission output speed implausible or no message

**Hall sensors monitoring:** The plausibility of the actuating motor Hall sensors is continually checked. When there are deviations that are out of tolerance, partial shut down (only Dynamic Braking available) is implemented and the "Parking Brake Actuating Unit Defective, Plausibility of Hall Sensors" fault code will be set.

In addition, the plausibility of the position is checked during the actuating motor operation. When the Hall sensor signal is not received, the parking brake system is shut down and a fault code will be set.

**EMF actuating unit monitoring:** After the ignition is switched on and a fault is present, it will be detected before a required parking brake function is active.

## EMF Self Diagnostics

The self diagnostic functions are divided into several modes. These modes are executed in priority for diagnosis. When the vehicle is stationary and self diagnosis is being executed, the parking brake function is fully operational. Fewer diagnostic modes are allowed while the vehicle is moving. A self diagnostic mode that will restrict or completely deactivate the parking brake function is executed only when the vehicle is stationary.

---

Certain faults in CAN communication will cause the manual emergency mode and the Automatic Hold will not function. The "manual level" is operational and the parking brake will still be applied and released by the EMF or DSC when the push button is pressed with the vehicle stationary. Dynamic Braking also remains available. The loss of the Automatic Hold function is indicated only with the variable parking brake indicator lamp.

## Workshop Hints

Please familiarize yourself with the statements below regarding new procedures when making repairs to the Electro-mechanical Parking Brake. Consult the Repair Information in TIS for additional information on the following procedures:

The parking brake shoes are adjusted the same way as current BMW models by turning the adjuster with a screwdriver through the wheel bolt hole of the wheel hub.

***Parking brake cable removal:*** To remove the parking brake cable assemblies, the EMF top cover must be removed and the end stop plate must be raised with a screwdriver. Using the brake release tool (found in the vehicle tool kit), release the parking brake completely so that the balance arm is turned back to the stop. This will allow the pulleys to rotate far enough so that the cable crimp can be disengaged from the recess in the pulley.

***Parking brake initialization:*** The parking brake must be initialized with the DISplus after replacing the brake shoes. The brake cable "free play" is learned by the EMF control module from the Hall sensors in the actuating motor.

***Parking brake lining seating:*** When the parking brake shoes are replaced, the new brake linings must be seated (bedded down) to achieve adequate holding power. A "Special Bedding Down Routine" is integrated in the parking brake software and can be accessed with the DISplus found under ***Service Functions - Chassis - Parking Brake - Workshop Braking-in.***

The parking brake indicator light in the instrument cluster will flash red (at a low frequency) to signal the standby status of the brake bedding down program. After activating the program, the ignition must not be switched off and the bedding down procedure must be carried out within 30 minutes.

If more than 30 minutes have lapsed, the parking brake button is pushed, or the ignition is turned off before the procedure is carried out, the brake bedding down program will be terminated. The system will resume the normal parking brake function.

---

The brake linings are seated by the EMF applying a reduced holding force. The braking force at the spindle during this procedure is 20% of the maximum actuating force.

The procedure is activated when the vehicle is stationary (for example: stopped at a traffic light). The brake shoes “scrub” when the vehicle starts off. The EMF releases the parking brakes when a speed of 15 km/h is reached or 30 seconds after the start of the seating procedure.

For safety reasons, the seating procedure is immediately terminated when any DSC function is required. The seating procedure is also terminated when the push button is pressed or the ignition is turned off.

**Travel monitoring:** Normal parking brake lining wear increases the actuating travel over the service life. Based on the reference point (stop in the EMF unit), the Hall sensors in the actuating motor allows the EMF control module to measure the travel range.

When the defined travel limit is exceeded, information is provided to the driver and a fault is stored in the EMF control module. This can also be checked using the DISplus found under *Service Functions - Chassis - Parking Brake - Position Travel Check*.

**Brake testing on a roller dynamometer:** The E65 parking brake operation can be tested on a brake roller dynamometer. The parking brake test can be conducted with the engine running by pressing the parking brake push button. With the engine turned off, the parking brake test can be activated by pressing the parking brake push button. The actuating unit will quickly apply and lock the parking brake.



**Assembly Mode:** Replacement EMFs are shipped in “assembly mode” to suppress activation until the brake cables and EMF are completely assembled and installed in the vehicle. This prevents unintentional operation of the EMF by the parking brake push button and can also be activated (for safety reasons) on an existing EMF in the vehicle when work is being performed.



**Before initial operation, the assembly mode must be deactivated by using the DISplus found under: Service Functions - Chassis - Parking Brake - Assembly Mode.**

When installing the EMF, make sure that the seal to the body and the seals for the parking brake cables are correctly installed.

**Coding data:** The coding data for the parking brake system is stored in the EMF control module (EEPROM) and the DSC control module (EEPROM). The coding data is entered by the DISplus when a control module is replaced.

## Check Control and Control Display Fault Descriptions

	Parking brake lamp	
	 KT-8140	
Cause	CC message	Control display information
Rest condition		
	Parking brake lamp	Variable indicator lamp
	 KT-8140	 KT-8139
Cause	CC Message	Control display information
Held mechanically (up to 10km/h); parking brake inoperative while driving; Parking brake can only be Operated manually	Parking brake inoperative while driving	Parking brake only be applied or released manually with the vehicle stationary. Parking brake without emergency function.
Mechanically released; parking brake can only be Operated manually	Parking brake automatic hold inoperative!	Parking brake not operated automatically when vehicle stopped/parked. Operate parking brake manually or use gearbox position P
Held mechanically or held hydraulically in dynamic braking mode when stationary; parking brake can only be operated manually	Parking brake Automatic Hold inoperative!	Parking brake not operative Automatic when vehicle Stopped/parked. Operate Parking brake manually or use gear box position P
Actuating unit failure while Driving; held hydraulic in dynamic braking mode when stationary	Parking brake automatic hold Inoperative/park with P	When driving off: release Parking brake with emergency release function if necessary. First engage gearbox position P! Use gearbox position P when parking

Parking brake overheated (only with engine off)	<ol style="list-style-type: none"> <li>1. Parking brake overheated, avoid operation</li> <li>2. Parking brake Overheated operation not possible</li> </ol>	<ol style="list-style-type: none"> <li>1. Parking brake overheated due to too frequent operation. Holding force reduced, risk of damage!</li> <li>2. Parking brake overheated due to frequent operation. Operation with vehicle Stationary no longer possible. Emergency braking function during vehicle operation still maintained.</li> </ol>
Overheating; held hydraulically in Dynamic braking mode up to stop	Parking brake overheated, Operation not possible	Parking brake overheated due to Too frequent operation. Operation with vehicle stationary No longer possible. Emergency braking function During vehicle operation still maintained.
Parking brake overheated	<ol style="list-style-type: none"> <li>1. Parking brake overheated. avoid operation</li> <li>2. Parking brake Inoperative while driving!</li> </ol>	<ol style="list-style-type: none"> <li>1. Parking brake overheated due to frequent operation. Holding force reduced, risk of damage!</li> <li>2. Parking brake can only be applied or released manually with the vehicle stationary. Parking brake without Emergency brake function.</li> </ol>
	Parking brake lamp	Variable indicator lamp
		
Cause	CC message	Control display function
Actuating unit failure	Parking brake inoperative / park with P	When driving off: release Parking brake with emergency Release function if necessary. First engage gearbox position P! When parking: use gearbox Position P.
Actuating unit failure on first Occurrence	<ol style="list-style-type: none"> <li>1. Risk of damage to parking Brake!</li> <li>2. Parking brake inoperative/park with P</li> </ol>	When driving off: release parking brake with emergency Release function if necessary. First engage gearbox position P! When parking: use gearbox Position P.

Overheating (reversible)	Parking brake overheated, Operation not possible	Parking brake overheated due to frequent operation. Operation with vehicle stationary no longer possible. Emergency braking function during vehicle operation still maintained.
Released mechanically; parking brake inoperative While driving; parking brake can only be operated manually	Parking brake inoperative While driving	Parking brake can only be Applied or released manually with the vehicle stationary. Parking brake without emergency brake function.
Parking brake overheated	1. Parking brake overheated, avoid operation 2. Parking brake inoperative while driving	1. Parking brake overheated due to frequent operation Holding force reduced, Risk of damage!  2. Parking brake can only be applied to released manually with the vehicle stationary. Parking brake without emergency brake function.
Alive failure or total failure	Parking brake inoperative / park with P	Parking brake inoperative. To park: use gearbox position P. To start off: if necessary, release brake with emergency release function. First engage gearbox position P! Visit nearest BMW Service Center
Alive failure or total failure On first occurrence	1. Risk of damage to parking brake! 2. Parking brake inoperative, park with P	Parking brake inoperative. To park; use gearbox position P. to start off: if necessary, release brake with emergency release function. First engage gearbox position P! Visit nearest BMW Service Center

**Notes:** \_\_\_\_\_

\_\_\_\_\_

\_\_\_\_\_

\_\_\_\_\_



\_\_\_\_\_

\_\_\_\_\_

\_\_\_\_\_

\_\_\_\_\_

\_\_\_\_\_

	Parking brake lamp	Variable indicator Lamp
		
Cause	CC message	Control display information
Overheating (reversible), dynamic braking during vehicle operation	<ol style="list-style-type: none"> <li>1. Release parking brake</li> <li>2. Parking brake overheated operation not possible</li> </ol>	Parking brake overheated due to frequent operation. Operation with vehicle stationary no longer possible. Emergency braking function During vehicle operation still maintained.
Dynamic braking during Vehicle operation	<ol style="list-style-type: none"> <li>1. Release parking brake</li> <li>2. Parking brake automatic hold inoperative</li> </ol>	Parking brake not operated Automatically when vehicle Stopped/parked. Operate parking brake manually or use gearbox position P.
Failure during vehicle operation; dynamic braking during vehicle operation	<ol style="list-style-type: none"> <li>1. Release parking brake</li> <li>2. Parking brake inoperative/park with P</li> </ol>	When driving off: release parking brake with emergency release function if necessary. First engage gearbox position P! when parking: use gearbox position P.

Notes: \_\_\_\_\_

\_\_\_\_\_

\_\_\_\_\_

\_\_\_\_\_

\_\_\_\_\_

\_\_\_\_\_

\_\_\_\_\_

\_\_\_\_\_

\_\_\_\_\_







\_\_\_\_\_

\_\_\_\_\_



\_\_\_\_\_

\_\_\_\_\_

\_\_\_\_\_

	Parking brake lamp	Variable indicator lamp
	 Flashing 	
Cause	CC message	Control display information
When stationary with engine off, while mechanically releasing or applying brake	Parking brake automatic hold inoperative!	Parking brake not operated
	Parking brake lamp	Variable indicator lamp
	 Flashing 	
Cause	CC message	Control display information
Total failure due to redundancy fault in parking brake push-button; flashing at high frequency for a certain time when push-button pressed (rapid flashing with gong)	Parking brake inoperative/ Park with P	Parking brake inoperative. To park: use gearbox position P. To start off: if necessary, release brake with emergency release function. First engage gearbox position P! Visit nearest BMW Service Center.



	Parking brake lamp	Variable indicator lamp
	 KT-8141  flashing   KT-8139	 KT-8139
Cause	CC message	Control display information
When stationary (up to 10km/h) while mechanically releasing or applying brake; (slow flashing->coding data instrument cluster)	Parking brake inoperative while driving	Parking brake can only be Applied or released manually with the vehicle stationary. Parking brake without emergency brake function.

Notes: \_\_\_\_\_

\_\_\_\_\_

\_\_\_\_\_

\_\_\_\_\_

\_\_\_\_\_

\_\_\_\_\_

\_\_\_\_\_

\_\_\_\_\_

\_\_\_\_\_

\_\_\_\_\_

\_\_\_\_\_

\_\_\_\_\_

\_\_\_\_\_

\_\_\_\_\_

\_\_\_\_\_

\_\_\_\_\_

\_\_\_\_\_

\_\_\_\_\_

\_\_\_\_\_

\_\_\_\_\_

\_\_\_\_\_

\_\_\_\_\_

\_\_\_\_\_